



User Manual

MiVue™ 798 / 798D

Revision: R00
(4/2019)

Disclaimer

The screenshots in this manual may differ between different operating systems and software versions. You can download the latest User Manual of your product from Mio™ website (www.mio.com).

Specifications and documents are subject to change without notice. MiTAC does not warrant this document is error-free. MiTAC assumes no liability for damage incurred directly or indirectly from errors, omissions or discrepancies between the device and the documents.

Note

Not all models are available in all regions.

Depending on the specific model purchased, the colour and look of your device and accessories may not exactly match the graphics shown in this document.

MiTAC Europe Ltd.
Spectrum House, Beehive Ring Road,
London Gatwick Airport, RH6 0LG,
UNITED KINGDOM

Table of Contents

Getting to know your dash cam	4
Using your dash cam in a vehicle.....	5
Precautions and notices	5
Mounting the dash cam	6
MiVue rear camera	7
Using a memory card	8
Formatting a card	8
Turning the dash cam on	8
Power button	8
Restarting the dash cam	9
System icons	9
Function keys	10
Switching screens	10
Setting the date and time	11
Recording in driving mode.....	11
Continuous recording	11
Event recording	12
Parking mode	12
Camera mode.....	13
Playback mode.....	14
Safety camera alerts	15
Adding a safety camera.....	15
Updating safety camera data	16

Getting connected	16
MiVue Pro app.....	16
Setting up a WIFI connection	17
System settings	18
MiVue Manager	23
Installing MiVue Manager.....	23
Playing the recording files	23
For more information	26
Caring for your device	26
Safety precautions.....	27
About charging	27
About the charger.....	27
About the battery	27
About GPS	28
Regulatory information	28
Declaration of conformity	29
WEEE.....	29

Getting to know your dash cam

Note: The screenshots and other presentations shown in this manual may differ from the ones generated by the actual product.

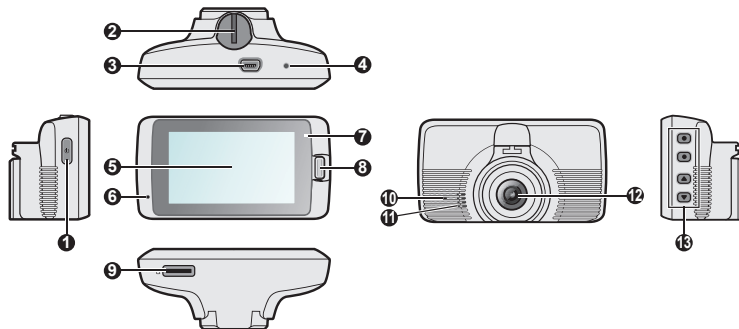

- | | | |
|-----------------------|---------------------|-----------------|
| ❶ Power button | ❸ Microphone | ❺ Speaker |
| ❷ Device mount socket | ❹ System indicator | ❻ Camera lens |
| ❸ Mini-USB connector | ❷ Event button | ❼ Function keys |
| ❹ Shutdown button | ❸ Memory card slot | |
| ❺ LCD screen | ❹ Parking indicator | |

Using your dash cam in a vehicle

Precautions and notices

- Do not operate the device while driving. Using this product does not change the requirement for a driver to take full responsibility for his or her behavior. This responsibility includes observing all traffic rules and regulations in order to avoid accidents, personal injury or property damage.
- A window mount is needed when using the dash cam in a car. Make sure that you place the dash cam in an appropriate place, so as not to obstruct the driver's view or deployment of airbags.
- Make sure that no object is blocking the camera lens and no reflective material is placed near the lens. Please keep the lens clean.
- If the car's windscreen is tinted with a coating, it may impact the recording quality.
- To ensure the highest quality recordings, you are advised to place the dash cam near the rear view mirror.
- Select an appropriate location for mounting the device in a vehicle. Never place the device where the driver's field of vision is blocked.
- If the car's windscreen is tinted with a reflective coating, it may be athermic and impact the GPS reception. In this instance, please mount your device where there is a "clear area."
- The system will automatically calibrate the G sensor of the device during start-up. To avoid G sensor malfunction, always turn the device on AFTER you mount it in the vehicle properly.

Mounting the dash cam

Make sure that your car is parked on level ground. Follow the instructions to mount your dash cam in a vehicle securely.

1. Before attaching the device mount to the windscreen, it is recommended to clean the windscreen with rubbing alcohol and make sure that the installation area is free of dust, oil and grease. Attach the mount to the windscreen (1), and press the tab (2) to lock the suction cup in place.

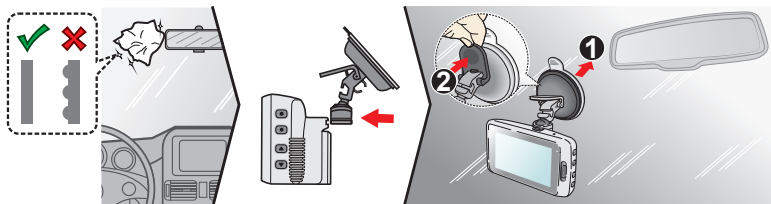

2. When adjusting the angle of mounting, make sure that the camera's view is parallel with the level ground and the ground/sky ratio is close to 6/4.
3. Route the cable through the top ceiling and the A-pillar so that it does not interfere with driving. Make sure that the cable installation does not interfere with the vehicle's airbags or other safety features.

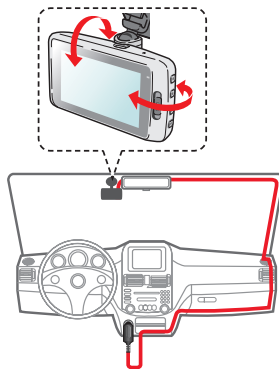

Note: The installation illustrations are for your reference only. The placement of the devices and cables may vary depending on the vehicle model. If you encounter any problems during installation, contact a skilled installer (such as the service personnel of the vehicle) for assistance.

MiVue rear camera

Depending on your model, your device may support a rear camera (may be sold separately).

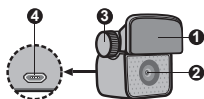

- 1 Mounting pad
- 2 Camera lens
- 3 Adjustment bolt
- 4 Micro-USB connector

Follow the illustration to connect the rear camera to the dash cam.

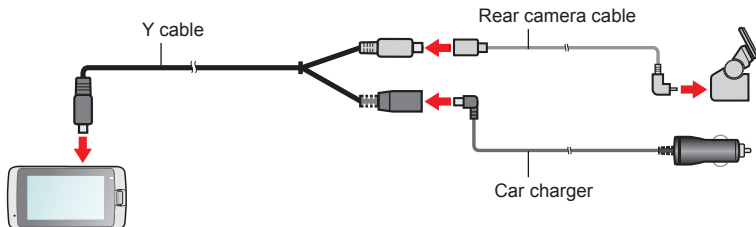

Using a memory card

Note:

- DO NOT apply pressure to the centre of the memory card.
- MiTAC does not guarantee the product's compatibility with memory cards from all manufacturers.
- Before you start recording, please format the memory card to avoid malfunction caused by files not created by the dash cam.
- Turn the device off before removing the memory card.

You must insert a memory card (not supplied) before you can start recording. The dash cam supports the Class 10 memory cards with 8 GB – 128 GB capacity. You should use separate MicroSD cards for recording and for regular data storage.

Hold the card (MicroSD) by the edges and gently insert it into the slot as shown in the illustration.

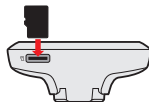

To remove a card, gently push the top edge of the card inwards to release it and pull it out of the slot.

Formatting a card

To format a memory card (all data will be erased), press  > **Format**.

Turning the dash cam on

Complete the installation according to the instructions in the “Using your dash cam in a vehicle” section. Once the vehicle engine is started, the dash cam automatically turns on. The System indicator glows in green when the dash cam is powered.

Power button

Press and hold the Power button for 2 seconds to manually turn the dash cam on and off. When the dash cam is turned on, press to switch the LCD screen on and off.

Restarting the dash cam

Occasionally, you may need to perform a hardware reset when the dash cam stops responding or if it appears to be “frozen” or unresponsive. To restart the dash cam, press and hold the Power button until the system powers off; press the Power button again to turn the dash cam on.

If the system does not shut down by keeping the Power button pressed, you can force it to shut down by inserting a small rod (such as a straightened paperclip) into the Shutdown button on the device.

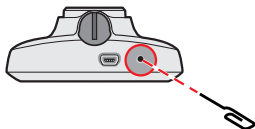

System icons

Various system icons on the status bar at the top of the screen provide the status information of your device. The icons displayed will vary depending on your device model and state.

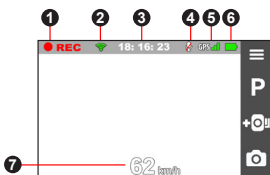

- 1 Recording indicator
- 2 WIFI status
- 3 Time display
- 4 Microphone status
- 5 GPS signal
- 6 Power status
- 7 Current GPS car speed

Function keys

The device provides four function keys to control the corresponding icons displayed on the LCD screen. The keys' functions may vary on different screens.

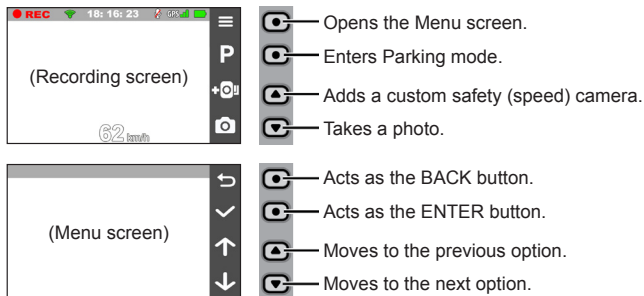



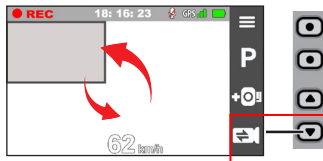

Switching screens

Once you connect the rear camera and start recording, the screen displays the PIP (picture-in-picture) mode. You can switch the front and rear camera images by pressing  .



Setting the date and time



To make sure that the date and time of your recordings are correct, check the settings before you begin recording.

1. Press  > **System** > **Date/Time**.
2. Do one of the following:
 - Select **Use GPS time**, and then select the time zone of your location. The system will set date and time according to the GPS location.
 - Select **Manual**, and the system will display the date and time setting screen. Use  /  to adjust the value of the selected field; press  and repeat the step until all fields have been changed. When done, press .

Recording in driving mode

Continuous recording

The system will automatically begin continuous recording in few seconds after start-up. The System indicator flashes in green and amber alternately while the recording is in progress.

When continuous recording is in progress, you can manually stop recording by pressing . Press  to return to the recording screen; the system will start continuous recording automatically.

The recording may be divided into several video clips; recording will not stop between video clips. When your memory card fills up with continuous recordings, it will automatically record over the oldest existing files in this category.

The continuous recordings can be found in the “Normal” category for file playback.

Event recording

By default, if an event happens such as a sudden impact, high speed driving, an aggressive turn or an accidental crash during continuous recording, the G sensor will prompt the dash cam to start recording the event.

Note: You can change the sensitivity level of the G sensor by selecting  > **Video Recording** > **G-Sensor Sensitivity**.

The event recording will save moments before and moments after the event. When your memory card fills up with event recordings, it will automatically record over the oldest existing files in this category.



If you want to manually start an event recording while continuous recording is in progress, press the Event button.

The event recordings can be found in the “Event” category for file playback.

Parking mode

Your dash cam supports the parking recording function. You must use an additional power source to record the video during the Parking mode, such as a Mio uninterruptible power cable which is sold separately. For more information on using a Mio power cable, see the provided documentation in its package.

The Parking mode is disabled by default. Before enabling the Parking mode, please check the memory storage allocation of your device. Select  > **System** > **Storage Allocation** to set a proper allocation for parking recording. Changing the allocation will erase the memory card, so save any videos or photos to your computer first.

You can enable the function by selecting  > **Parking Mode** > **Detection** > **On**. (The  icon will appear on the screen.) When the Parking mode detection is enabled, the system will enter the Parking mode when the car stops moving for about 5 minutes.

In the Parking mode, parking recordings could be triggered only when movements or vibrations are detected. The parking recording will save the duration from seconds before the event until seconds after the event. When your memory card fills up with parking recordings, it will automatically record over the oldest existing files in this category.

Note:

- You can press **P** to manually enter the Parking mode while continuous recording is in progress.
- The parking recording is triggered by the G sensor and motion detection of the device. You can change the configuration by selecting **☰** > **Parking mode** > **Motion Detection** and **G-Sensor Sensitivity**.
- The rear camera (optional) does not support motion detection.

To exit the Parking mode and resume continuous recording, press **↶**. If movements are detected and recorded during the Parking mode, you will be asked to playback the video when you exit the Parking mode.

The parking recordings can be found in the “Parking” category for file playback.

Camera mode











The dash cam allows you to take a photo.

- If the recording is in progress, press **📷** to take a photo. (This function is not available when the rear camera is connected.)
- Press **☰** > **Camera** > **📷**.

The photos can be found in the “Photo” category for file playback.

Playback mode

To select a video or photo for playback:

1. Press  > **File Playback**.
 2. Select the desired type.
 3. Press  /  to select the desired file from the list and then press  to start playback.
 4. During playback, you can:
 - Press  to return to the list.
 - While playing videos, press  /  to play the previous/next video.
Press  to display the pop-up menu to select:
 - **Play / Pause:** Starts or pauses the playback.
 - **Play rear video / Play front video:** The "D" icon displayed on the thumbnail on the playlist indicates that the video comes with a corresponding rear video. While playing the video, you can use this option to switch between the front and rear videos.
- Note:** The video files recorded by the front and rear cameras will be saved separately in the corresponding folders of the memory card. If you move or delete a front video, its corresponding rear video will be processed synchronously.
- **Move to Event:** Moves the file to the "Event" category.
 - **Transfer video / Transfer photo:** Uploads the selected video/photo to your smartphone.
 - **Delete:** Deletes the file.
- While viewing photos, press  /  to display the previous/next photo.
Press  to delete the file.

Safety camera alerts

Note: For legal reasons, the safety camera function is not available in all countries.

You can receive alerts to warn you about the locations of safety (speed) cameras which will enable you to monitor your speed through these areas.

When a safety camera appears and is positioned in the detectable direction, you will receive alerts. The screen will display the visual alert and you will also receive audio warnings.

When the alert sound setting is set to **Beep**:

- When your car approaches a safety camera, you will receive a normal beep alert.
- When your car approaches a safety camera at a speed over the set threshold, you will receive a persistent beep alert until your car speed drops lower than the appropriate speed limit.
- When your car passes through a safety camera, you will be notified by a different beep alert.

You can change the settings about how you want to receive the safety camera alerts. See the “System settings” section for information.



Adding a safety camera

Note: You can add a custom safety camera only when a GPS fix is established.

Your dash cam allows you to customise the safety camera database. You can add up to 100 custom safety cameras in your dash cam.

Follow the steps to configure a custom safety camera:



1. To add a custom safety camera in the current location, press  on the recording screen.
2. The next time when you pass by the location, you will receive alerts by the dash cam.
3. To view the information of the custom safety camera, select  > **SafetyCam** > **Custom SafetyCam** and then select the safety camera that you want to check.
4. Press  to remove the custom safety camera from the dash cam.

Updating safety camera data

MiTAC does not warrant that all types and locations of safety camera data are available as cameras may be removed, relocated or new cameras installed.

Occasionally, MiTAC may offer you updates of safety camera data. Visit the Mio website for available downloads and follow the instructions to complete update.

Getting connected

MiVue Pro app

The MiVue Pro app allows you to view, share and back up the videos recorded on a MiVue dash cam via WIFI. Search for "MiVue Pro" in Apple App Store or in Google Play Store to download the app for free.

Note:

- The MiVue Pro app is compatible with iOS 9.0 (and above) and Android 5.0 (and above) devices. MiTAC does not guarantee the product's compatibility with smartphones from all manufacturers.
- Not all MiVue dash cam models support the MiVue Pro app or all its features.

Setting up a WIFI connection

The WIFI function allows you to connect the dash cam to your smartphone. The WIFI function is disabled by default. You can enable WIFI by selecting  > **WIFI** > **On**. Once enabled, the WIFI setting screen displays the SSID and password of the dash cam.

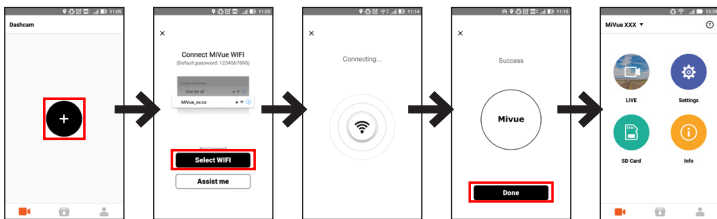

On your smartphone, follow the steps to set up the WIFI connection.

1. Make sure that you have enabled the WIFI function on the smartphone.
2. Open the MiVue Pro app and tap the "+" icon.
3. Tap **Select WIFI** and then select the dash cam you want to connect to.
4. Tap **Done** to complete the WIFI connection.
5. Once the devices are connected, the screen will display the main page ().



Note: The WIFI connection between your Mio and smartphone is not Internet-enabled.

You can check the WIFI connection status by the WIFI icon on the dash cam.

	The dash cam is connected to the smartphone and paired with the MiVue Pro app.
	The dash cam is not connected to the smartphone.



The dash cam is connected to the smartphone but not paired with the MiVue Pro app yet.

On your smartphone, open the MiVue Pro app and keep it awake. You can now transfer videos by pressing the Event button.

System settings

Note: Not all setting items and options are available for all models.

To customise the system settings, press  .

- **File Playback**

Plays the recorded videos and photos.

- **Camera**

Press to enter Camera mode.

- **WIFI**

Enables or disables WIFI.

- **Sound Recording**

Sets if you want to include sounds in the recordings.

- **TPMS**

TPMS (Tyre Pressure Monitoring System) is an electronic assistant device installed in the car's tyres to monitor the air pressure via your MiVue dash cam. You will receive alerts if the tyres are under (or over) inflated.

To configure the TPMS settings, press  .

- **Units:** Sets the unit of the pressure (psi, Bar, kPa or kg/cm²) and temperature (°C or °F).

- **Front Tyre Sensors:** Sets the minimum/maximum pressure and maximum temperature for the front tyres.
- **Rear Tyre Sensors:** Sets the minimum/maximum pressure and maximum temperature for the rear tyres.
- **Sensor Location:** Sets the sensors' locations.
- **Learning Mode:** When new TPMS sensors are installed, use this option for the dash cam to detect the new sensors.

Note: For more information on installing and using TPMS, see the documentation that comes with the product.

• Driving Safety

The dash cam provides advanced driving safety functions to make your driving safer.

- **Calibration:** Follow the steps to calibrate the system.
 1. Drive the vehicle in the middle of the lane.
 2. Ask a passenger to select this option and then follow the on-screen instructions to complete calibration.



Note: You are advised to calibrate the system constantly in order to be alerted properly.

- **LDWS:** Select **BEEP** or **VOICE** to enable the LDWS (Lane Departure Warning System) function. The system will alert you when it detects that the GPS car speed is over 60 km/h and the car has strayed from its intended lane.
- **Headlight Reminder:** Once enabled, the system will remind you to turn the lights on when you are driving after dark. The default setting is **Off**.

- **Driver Fatigue Alert:** Once enabled, the system will remind you to take a break for a long-distance drive (**2 hours, 3 hours or 4 hours**). The default setting is **Off**.
- **Eco Drive Indicator:** Once enabled, the system will display the Eco drive indicator on the screen. The colour of the indicator will change (red, yellow or green) depending on your driving status to remind you to drive more efficiently. The default setting is **Off**.
- **FCWS:** Select **Beep** or **Voice** to enable the FCWS (Forward Collision Warning System) function. The system will alert you when the car moves slowly and gets too close to the car ahead.
- **Stop and Go:** Once enabled, the system will alert you when the car ahead has proceeded to go after being stopped for longer than 10 seconds. The default setting is **Off**.
- **SafetyCam**

Sets how you want to be notified of safety cameras. The available settings include:

- **Alert Sound:** Turns on (**Beep** or **Voice**) or off (**Mute**) the alert sound.
- **Alert Distance:** The system will alert you at a preset distance (**Short, Medium** or **Long**) when a safety camera is detected.
- **Alert Method:** Sets the alert distance function according to the current GPS car speed (**Smart Alert**) or the speed limit (**Standard Alert**).
- **Threshold:** Sets the speed value for the dash cam to start offering alerts.
- **Cruise Speed Alert:** Sets the limit for the cruise speed. When you drive at a cruise speed over the set value, you will receive alerts by the dash cam.
- **Custom SafetyCam:** Lists all custom safety cameras which are sorted by the created time.

- **Parking Mode**

Allows you to change the settings of Parking mode. The available settings include:

- **Detection:** When enabled, the dash cam will automatically start recording when it detects movements or if an event happens in Parking mode.
- **Detection Method:** Sets the parking detection method to **Only G-sensor**, **Only Motion** or **Both Motion & G-sensor**.
- **Auto Entry:** Sets the mode (**Low**, **Medium**, **High** or **Manual**) for the system to enter Parking mode automatically.
- **Motion Detection:** Sets the sensitivity level of motion detection to **Low**, **Medium** or **High**.
- **G-Sensor Sensitivity:** Sets the sensitivity level of the G sensor that allows automatic triggering of the parking recording when the dash cam is in Parking mode.
- **LED Indicator:** Turns on or off the parking indicator.

- **Video Recording**

Changes the settings of recording, including:

- **Video Clip Length:** Sets the length of each video clip for a continuous recording.
- **Video Resolution:** Sets the resolution of the video.
- **WDR:** Enables the Wide Dynamic Range (WDR) function to improve the dash cam's image quality under high-contrast lighting conditions.
- **EV:** Sets the exposure level to adjust the brightness of the image.
- **Frequency:** Sets the frequency for the camera to avoid problems caused by artificial light sources that are not constant.

- **G-Sensor Sensitivity:** Sets the sensitivity level of the G sensor that allows automatic triggering of the event recording while continuous recording is in progress.
- **Stamps:** Sets the information (**Coordinates** or **G-Sensor**) that will be displayed on the recorded video.
- **Speed stamp:** Displays the driving speed on the recorded video.
- **Text stamp:** Displays customisable text information.
- **System**

Allows you to change the system settings of the device.

- **Satellites:** Displays the status of the GPS/GLONASS signal reception. You can press  and then select GPS or GLONASS for better signal reception if the need arises.
- **Date/Time:** Sets the system date and time.
- **System Sound:** Enables or disables system notification sounds.
- **Welcome Sound:** Enables or disables the notification sounds during start-up.
- **Volume:** Adjusts the volume level.
- **LCD Standby**
 - **Always On:** Keeps the LCD on.
 - **HUD:** Turns off the LCD (in specified time) but still displays the time and speed information.
 - **10 sec / 1 min / 3 min:** Sets the timer for the LCD to turn off automatically after recording starts.
- **Language:** Sets the language.
- **Distance Unit:** Sets the preferred distance unit.

- **Storage Allocation:** The system provides 3 default memory configurations to store the videos and photos. Select the proper configuration based on your usage.
- **Restore to Defaults:** Restores the system settings to the factory defaults.
- **Version:** Displays the software information.
- **Format**
Formats a memory card. (All data will be erased.)

MiVue Manager

MiVue Manager™ is a tool for you to view the videos recorded on a MiVue dash cam.

Note: Not all features are available for every model.

Installing MiVue Manager

Download MiVue Manager from the Support page of Mio website (www.mio.com/support) and follow the on-screen prompts to install it. Make sure to download the correct software version (Windows or Mac) according to your computer's operating system.

Playing the recording files

1. Remove the memory card from the dash cam and access the card on the computer via a card reader. You are advised to copy the recording files to your computer for backup and playback.
2. Start MiVue Manager on the computer.
 - By default, MiVue Manager shows the calendar and the file list on the right.
 - When a recording file exists, you will see the date marked with “•.” Click that date to display the files that were recorded on that date.

- You can select the file type to display: **Event / Normal / Parking**.
 - To display all files in the current folder, click **All**. To return to the calendar view, click **Calendar**.
3. Double-click the desired file on the file list to start playback.
 4. The playback controls are described as follows:



- 1 Skips to the previous / next file on the list.
 - 2 Starts or pauses the playback.
 - 3 Changes the playback speed to 1/4x, 1/2x, 1x (default), 1.5x, or 2x.
 - 4 Mutes or unmutes the volume.
 - 5 Adjusts the volume level.
 - 6 Plays the video in full screen.
 - 7 Displays the playback progress. You can click on a point along the track bar to move directly to a different location for the playback.
5. During playback, you can view more driving information from the dashboard panel and the G sensor chart that are displayed below the video playback screen.
 - On the dashboard panel, click  to display the map screen.
 - The G sensor chart displays data in 3-axis waveform about the car's shift forward/backward (X), to the right/left (Y) and upward/downward (Z).

Note: The map screen may not display when the computer is not connected to the Internet or when your MiVue model does not support the GPS function.

6. The tool bar allows you to do the following:



- ① Selects the folder that stores the recording files.
- ② Previews and prints the current video image.
- ③ Saves the selected files to the specified location on your computer.
- ④ Captures and saves the current video image to the specified location on your computer.
- ⑤ Opens the Settings Menu.
 - **Change Language:** Sets the display language of MiVue Manager.
 - **Change Skin:** Sets the colour scheme of MiVue Manager.
 - **Check for Update:** Checks if there is any new version of MiVue Manager. (Internet access is required for this feature.)
 - **About:** Displays the version and copyright information of MiVue Manager.
- ⑥ Exports the GPS information of the selected file in the KML format to the specified location on your computer.
- ⑦ Uploads the selected file to Facebook / YouTube™.
- ⑧ In the playlist, the "F" and "R" marks displayed on the filename indicate that the video comes with a corresponding front video (F) or rear video (R). While playing the video, the screen displays the PIP (picture-in-picture) mode. You can switch the front and rear videos by clicking .

Note: This feature is for selected models only.

For more information

Caring for your device

Taking good care of your device will ensure trouble-free operation and reduce the risk of damage.

- Keep your device away from excessive moisture and extreme temperatures.
- Avoid exposing your device to direct sunlight or strong ultraviolet light for extended periods of time.
- Do not place anything on top of your device or drop objects on your device.
- Do not drop your device or subject it to severe shock.
- Do not subject your device to sudden and severe temperature changes. This could cause moisture condensation inside the unit, which could damage your device. In the event of moisture condensation, allow the device to dry out completely before use.
- The screen surface can easily be scratched. Avoid touching it with sharp objects. Non-adhesive generic screen protectors designed specifically for use on portable devices with LCD panels may be used to help protect the screen from minor scratches.
- Never clean your device with it powered on. Use a soft, lint-free cloth to wipe the screen and the exterior of your device.
- Do not use paper towels to clean the screen.
- Never attempt to disassemble, repair or make any modifications to your device. Disassembling, modifying or any attempt to repair could cause damage to your device, may inflict bodily harm or damage to property and will void any warranty.
- Do not store or carry flammable liquids, gases or explosive materials in the same compartment as your device, its parts or accessories.

- To discourage theft, do not leave the device and accessories in plain view in an unattended vehicle.
- Overheating may damage the device.

Safety precautions

About charging

- Use only the charger supplied with your device. Use of another type of charger may result in malfunction and/or danger.
- This product is intended to be supplied by a LISTED Power Unit marked with “LPS”, “Limited Power Source” and output rated + 5 V dc / 2.0 A.

About the charger

- Do not use the charger in a high moisture environment. Never touch the charger when your hands or feet are wet.
- Allow adequate ventilation around the charger when using it to operate the device or charge the battery. Do not cover the charger with paper or other objects that will reduce cooling. Do not use the charger while it is inside a carrying case.
- Connect the charger to a proper power source. The voltage requirements are found on the product case and/or packaging.
- Do not use the charger if the cord becomes damaged.
- Do not attempt to service the unit. There are no serviceable parts inside. Replace the unit if it is damaged or exposed to excess moisture.

About the battery

CAUTION! This unit contains a non-replaceable internal Lithium Ion battery. The battery can burst or explode, releasing hazardous chemicals. To reduce the risk of fire or burns do not disassemble, crush, puncture or dispose of in fire or water.

- Use a specified battery in the equipment.
- Important instructions (for service personnel only)

- Caution! Risk of explosion if battery is replaced by an incorrect type. Dispose of used batteries according to the instructions.
- Replace only with the same or equivalent type recommended by the manufacturer.
- The battery must be recycled or disposed of properly.
- Use the battery only in the specified equipment.

About GPS

- GPS is operated by the United States government, which is solely responsible for the performance of GPS. Any change to the GPS system can affect the accuracy of all GPS equipment.
- GPS satellite signals cannot pass through solid materials (except glass). When you are inside a tunnel or building, GPS positioning is not available. Signal reception can be affected by situations such as bad weather or dense overhead obstacles (such as trees, tunnels, viaducts and tall buildings).
- The GPS positioning data is for reference only.

Regulatory information

For regulatory identification purposes, MiVue 798/798D is assigned a model number of N548.



Products with the CE marking comply with the Radio Equipment Directive (RED) (2014/53/EU) - issued by the Commission of the European Community.

Compliance with these directives implies conformity to the following European Standards:

EN 55032: 2012 + AC: 2013

EN 55024: 2010 and CISPR 24: 2010

EN 61000-4-2: 2009 and IEC 61000-4-2: 2008

EN 61000-4-3: 2006 + A1: 2008 + A2: 2010 and IEC 61000-4-3: 2006 + A1: 2007 + A2: 2010

EN 61000-4-4: 2012 and IEC 61000-4-4: 2012

EN 61000-4-5: 2006 and IEC 61000-4-5: 2005

EN 61000-4-6: 2009 and IEC 61000-4-6: 2008

EN 61000-4-8: 2010 and IEC 61000-4-8: 2009

EN 61000-4-11: 2004 and IEC 61000-4-11: 2004

EN 301 489-1 V2.2.1 (2017-02)

EN 301 489-17 V3.1.1 (2017-02)

EN 301 489-3 V2.2.1: (2017-03)

ETSI EN 300 328 V2.1.1

EN 300 440 V2.1.1; 2017

IEC60950-1(ed.2); am1; am2

ISO7637-2: 2004

EN 62311: 2008

The manufacturer cannot be held responsible for modifications made by the User and the consequences thereof, which may alter the conformity of the product with the CE Marking.

Declaration of conformity

Hereby, MiTAC declares that this N548 is in compliance with the essential requirements and other relevant provisions of Directive 2014/53/EU.

WEEE



This product must not be disposed of as normal household waste, in accordance with the EU directive for waste electrical and electronic equipment (WEEE – 2012/19/EU). Instead, it should be disposed of by returning it to the point of sale, or to a municipal recycling collection point.